



Mass transfer analysis of an air curtain system

L. Guyonnaud and C. Sollicec

Ecole des Mines de Nantes

Département Systèmes Energétiques et Environnement

La Chantrerie, 4, rue Alfred Kastler – BP 20722

44307 Nantes cedex 03 (France)

Email: Camille.Sollicec@emn.fr

Abstract :

Air curtain systems can be used to prevent smoke propagation in the case of a tunnel fire. To study the performances of such devices, a scaled down model was designed at the Ecole des Mines de Nantes. Using experimental technics like hot wire anemometry or gas tracer detection, investigations on the influences of geometric and dynamic parameters give information about the design of the installations. It also explains how and where the mass transfer occurs through the air curtain.

1 Introduction

Air curtain systems are sometimes used as a substitute for solid doors. An air curtain is a plane air jet blown between two volumes. The main advantage of such virtual screens is to make easier frequent movements of people or materials while limiting heat and mass transfer through the opening. Our investigation deals with air curtains used as safety devices in walk, road, or railways tunnel in case of fire. The aim of such installations is to avoid mass transfer due to pressure difference in a subway. The air curtain must insure a minimum net flow in the upstream

140 Advances in Fluid Mechanics II

tunnel. For security applications, this condition must be well known, otherwise, the counter flow created by the air curtain could poke the fire.

So far, the mass transfer through an air curtain is not yet fully solved. Therefore, most installations are designed on the basis of specific experimental tests realized on full scale or scaled down physical models. Thus a wind tunnel was designed at the Ecole des Mines de Nantes to test the tightness of air curtains used for subways applications. The influence of geometric and dynamic parameters is studied by velocity fields, wall pressure and hydrocarbon concentration measurements. Laser visualizations provide qualitative information about the air curtain shape.

This paper presents a detailed description of the test bench and measurement technics. It also gives information about the air curtain design, based on extrapolation of scaled down model results. Mass transfers are analysed in the wind tunnel in order to better understand the fluid dynamic of such devices. The local mass transfer analysis locates the leakages.

2 Physic of air curtains

An air curtain is an impinging plane air jet subjected to a transversal pressure difference. According to the theory and referring to Rajaratnam [1], four regions make up the air curtain. Figure 1 illustrates them.

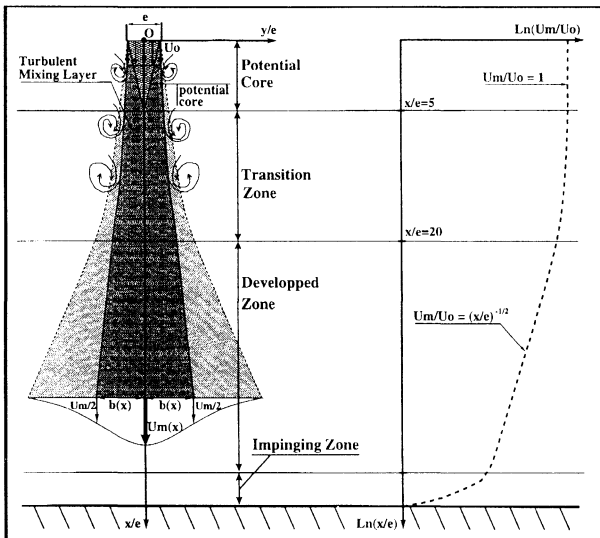

Figure 1 : Definition sketch of an impinging plane air jet

Potential core zone : In this region, located near the nozzle, the velocity remains constant and equal to the supply velocity U_0 . The turbulence intensity is also constant. Mixing layers due to the surrounding fluid entrainment limit this zone. According to Van and Howell [2], the potential core length is up to 8 times the jet thickness. It is strongly affected by the initial flow conditions and the nozzle shape.

Transition zone : This region begins with the velocity decay and the amplification of the jet expansion.

Developped zone : This zone starts approximatively after 20 times the nozzle width. In this region, the velocity decay remains constant. Theory gives the velocity decay expressed with non-dimensional quantities.

Impinging or recompression zone : In air curtain applications, depending on the tunnel height, only some of the first previous regions are present. In the most simple case we are in presence of the potential core and the impinging zone in the vicinity of the floor. In all cases, the flow field is very complex in the recompression zone. No detailed data are available in the bibliography.

Transversal pressure difference : Using the Euler equation, Hayes and Stoeker [3], Lajos [4] and Partyca [5] solved the problem of an air curtain stressed by a transversal pressure difference. For a single jet without impingement, and neglecting viscous and gravity forces, the air curtain curvature is a circle arc. When an impingement is present, this theory is not verified. Figure 2 presents a flow visualization and compares the experimental and theoretical curvatures of the air curtain.

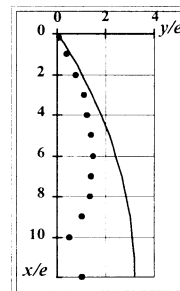
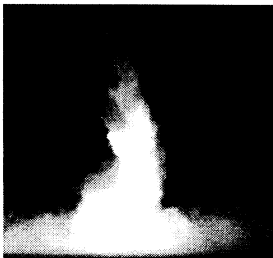

Figures 2 : Flow visualization, experimental (●) and theoretical (—) air curtain curvature induced by a transversal pressure gradient

3 Experimental devices and procedures

3.1 Experimental devices

The test bench is a wind tunnel (1.4 m width, 8 m length) with variable floor height. Figure 3 shows the general view of the installation. The air curtain formed by a plane jet is created by three fans with adjustable air supply velocity U_o . The air jet blows from top to bottom, the blowing angle is 30° . The maximum air supply velocity is about 30 m/s for the narrowest nozzle (i.e. 20 mm width). Its turbulence intensity is adjustable using turbulence grid from 0.5 to 20 %. The tunnel height H is also adjustable by floor displacement. This way, the height to thickness ratio H/e is variable from 0 to 48 for the smallest nozzle and from 0 to 18 for the largest one (i.e. 80 mm width). The pressure difference $\Delta P = P_1 - P_2$ from both sides of the air curtain is created with the main tunnel fans. We can continuously set it up from 0 to 50 Pa.

Experimental measurement facilities consist of a two components hot wire anemometer coupled with a micrometric displacement arm, an 8 W laser and a C.C.D camera allowing flow visualizations. Instantaneous pressure multichannel sensors (up to 64 static pressure taps) give the wall static pressure in the recompression zone. An hydrocarbon fast flame ionisation detector is used to measure the global and local mass transfers through the air curtain.

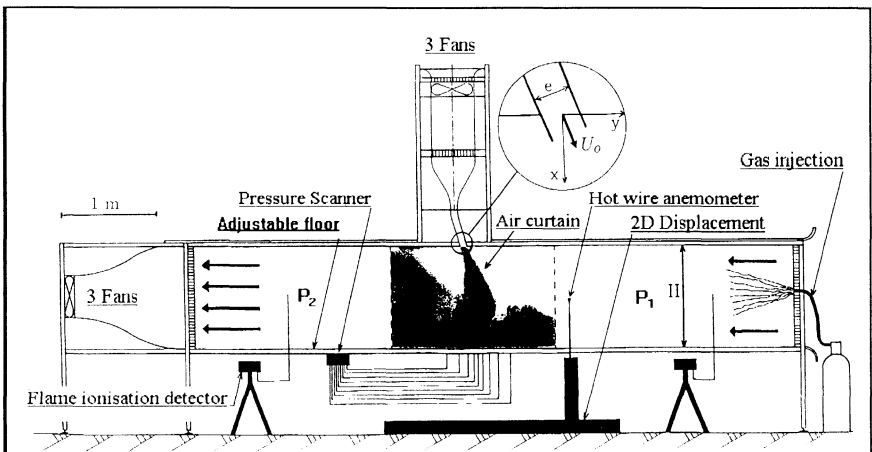

Figure 3 : Sketch of the test bench and experimental devices

3.2 Determination of the minimum net flow operating condition

Used for safety tunnel applications, the air curtain has to avoid mass transfer due to natural flow. In case of fire, the installation must give a minimum net flow in the upstream tunnel where the fire is located. If the supply velocity of the air curtain is not sufficient to counterbalance the transversal pressure difference, it allows smoke and toxic gas propagation downstream this virtual screen. In opposite, if the supply velocity is too large, the inversed flow in the tunnel can poke the fire. For these reasons, the air curtains are studied in a particular condition called *minimum net flow operating condition*. For each geometric configuration, this state joins up a transversal pressure difference $\Delta P = P_1 - P_2$ with the necessary supply velocity U_o . Therefore, the plane jet closes the tunnel opening by compensating the transversal pressure difference with its curvature.

3.3 Mass transfer measurement methodologies

Tightness or leakages of an air curtain are not easy to quantify. We use a concentration decay method based on gaseous tracer. The upstream volume is seeded with ethane as shown on figure 3. The concentration is set up to about 2000 ppm. At $t=0$ we open the upstream volume. Turbulent mass transport through the air curtain involves the decrease of the upstream volume concentration. The upstream tunnel mass budget gives the expression of the concentration decay as following :

$$C(t) = C_o e^{-\frac{q}{V}t} = C_o e^{-At} \quad (1)$$

$C(t)$: upstream tunnel concentration [ppm]

C_o : initial gas concentration in the upstream volume [ppm]

q : flow rate through the air curtain [$\text{m}^3 \cdot \text{s}^{-1}$]

V : volume of the confined space [m^3]

A : mass transfer coefficient [s^{-1}]

t : time [s]

Therefore, it is possible to compare the air curtain efficiency for different geometric and dynamic parameters. Extrapolation laws could be obtained by the analysis of the model scale change results.

4 Experimental results

4.1 Minimum net flow operating condition characterisation

Figure 4 compares the counterbalanced pressure difference with the dynamic pressure of the air jet. The air curtain operating set corresponds to the minimum net flow defined above. Its visualization is also reported on figure 4. For a given nozzle geometry, the slope of these curves is constant when the ratio H/e is kept constant. This slope is named Euler number. It represents the ratio of the pressure forces to the jet momentum forces. This result is in good agreement with the works of Hayes and Stoeker [3,], Lajos [4] or Partyca [5]. However, these authors indicate that the Euler number remains constant with model scale change. Our investigation point out an increase of the Euler number with the nozzle width. Then, if an installation is designed with scaled down model results, the actual air curtain will have a stronger velocity than necessary and will produce a reversed flow.

Our experimental bench also allows to test the influence of the supply velocity turbulence intensity I_o . As shown on figure 4, it appears that turbulence intensity does not affect the Euler number. This is an important conclusion because actual industrial applications have turbulence intensity of 15 % whereas laboratories used jets of less than 1 % of turbulence intensity. This result presents a great interest because it is very difficult and expensive to keep a low level of turbulence intensity at the jet nozzle on actual devices.

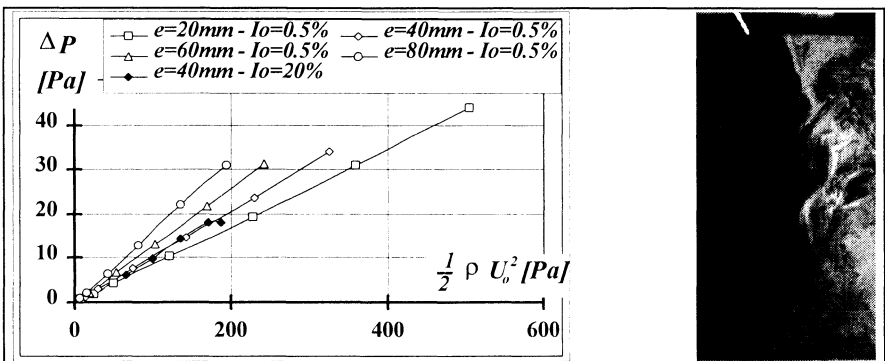

Figure 4 : Transversal pressure difference with the dynamic pressure of the jet, flow visualization of the curtain boundary.

4.2 Global and local leakage through the air curtain

According to the methodology presented before, air curtains efficiency is characterised by the mass transfer coefficient A . The first part of our investigation deals with the influence of the geometric and dynamic parameters (U_o , I_o , e and H) of the installation on the air curtain tightness (i.e on A). In the second part, the local mass transfer is analysed by means of local concentration measurements. Then we are able to locate the mass transfer through the plane jet and to explain how it occurs.

4.2.1 Global leakage

This section present a parametric study of the leakage level. Results are obtained by means of instantaneous concentrations measured in both sides of the curtain. Using the test bench, we can rate the nozzle width e , the tunnel height H , the transversal pressure difference ΔP , the average supply velocity U_o and its turbulence intensity I_o . Figure 5 gives an example of the upstream concentration decay for a 40 mm width air curtain. The tunnel height is 12 times the nozzle width. The average supply velocities used are respectively 12 and 24 m/s. The experiment easily shows the strong influence of the velocity U_o on the air curtain leakage. The mass transfer coefficient A approximatively doubles when the supply velocity of the jet doubles.

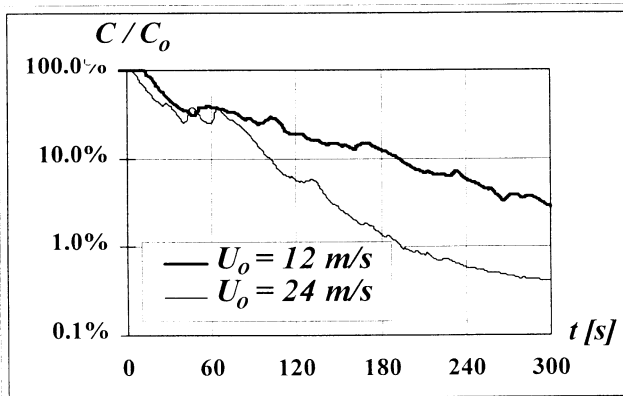

Figure 5 : Upstream concentration decay with the supply velocity U_o

The supply velocity seems to be the only parameter acting on the global mass transfer. Neither the turbulence intensity I_o nor the

geometric parameters e and H have any effect on the mass transfer coefficient. So for a constant tunnel height and a given air supply velocity, the increase of the nozzle width does not involve modifications of the transfer flow through the air curtain. We have shown that the Euler number is proportionnal to the jet thickness. Then the wider the nozzle is, the more the pressure drop created by the air curtain is important. So the thicker the jet is, the weaker the blowing velocity can be. To obtain a better tightness of the air curtain, it is recommended to use the lowest supply velocity and the thickest jet. These conditions are in full agreement with the comfort of the users.

4.2.2 Local mass transfer

To explain the mass transfer through the air curtain we need to analyse the dynamic of the jet in detail. The experimental methodology used is similar to the global mass transfer one. An unstationary method is also set up. The fast flame ionisation detector probe is settled on the axis flowline of the jet determined with hot wire anemometry (see figure 2). Figure 6 illustrates the mass transfer occurring between polluted upstream tunnel and this axis. In both potential core and transition zone, the mass transfer is very low. In this place, the molecular diffusion is preponderant compared to turbulent eddy mass transfer. Further downstream ($x/e = 8$), the local concentration increases. In the floor vicinity, i.e in the recompression zone ($x/e > 9$), the local concentration is the highest. The mass transfer seems to be due to the convection of polluted large eddies coming from the upstream part of the tunnel.

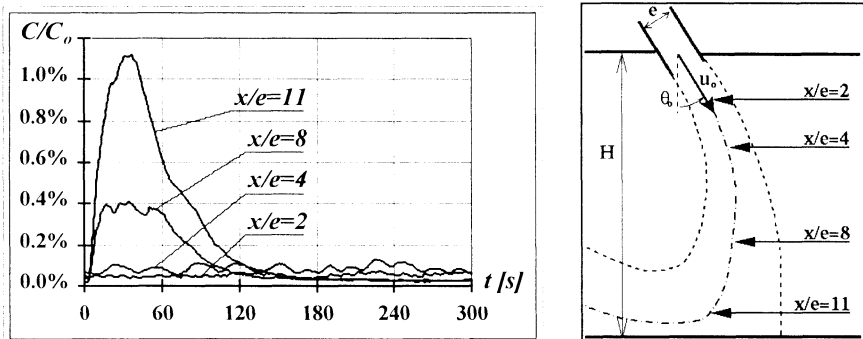

Figure 6 : Axial jet concentration with time

The air curtain instability and its flutter could also explain how instantaneous mass transfer occurs. It could be studied with the wall pressure coefficient time history analysis. Figure 7 shows the distribution of the average wall pressure coefficient for the minimum net flow operating condition.

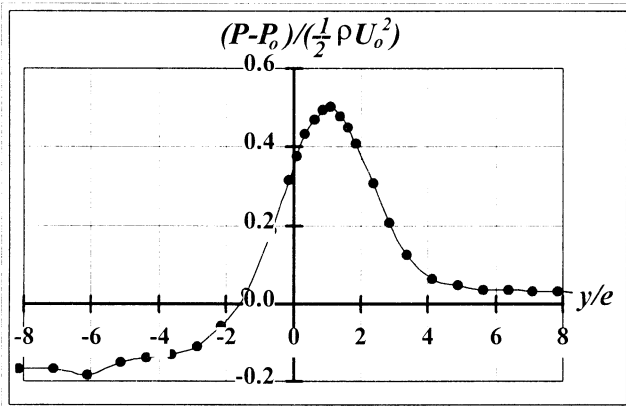

Figure 7 : Distribution of the time average wall pressure coefficient

The time history of the maximum pressure coefficient displacement is plotted on figure 8. The flutter of the stagnation point shows the air curtain instability.

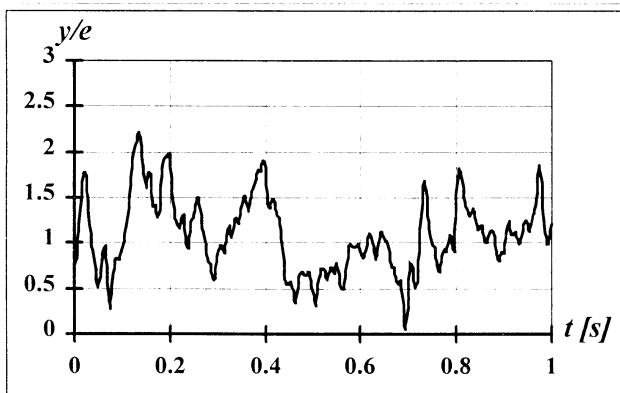

Figure 8 : Maximum pressure coefficient location with time



5 Conclusions

In this study we have confirmed the validity of the Euler number for a given tunnel geometry and for an air curtain nozzle shape. One of the main conclusions of this work is that the Euler number increases with the nozzle width. So the design of actual air curtains cannot be done by direct similarity based on keeping constant the Euler number measured on a reduced scale model.

Small leakages still exist when the air curtain induced a pressure drop strictly equal to the driving differential pressure. We have also pointed out that the initial turbulence intensity of the jet does not affect the operating point of the system.

Global concentration measurements show the strong influence of the air jet supply velocity on the installation tightness. Leakages are located in the floor vicinity, in the recompression zone. They seem to be generated by the convection of polluted eddies coming from the upstream volume.

Now, our investigations are concentrated on the study of the flutter of the impinging jet. We project to use P.I.V, velocity and concentration cross correlations to investigate the recompression zone more precisely. Further studies will test different nozzle shapes in order to reduce the jet flutter.

References

- [1] Rajaratnam, N., *Turbulent Jets*, Elsevier, Amsterdam, 1976.
- [2] Van, N.Q. & Howell, R.H., *Influence of Initial Turbulence Intensity on the Development of Plane Air-Curtain Jets*, Transactions of the ASHRAE No 2396, pp. 208-228, 1976.
- [3] Hayes, F.C. & Stoeker, W.F., *Heat Transfer Characteristics of The Air Curtains*, Transactions of The ASHRAE N° 2120, 1969.
- [4] Lajos, T., *Interactions of Air Curtain and the Protected Room*, Technical University of Budapest, 1975.
- [5] Partyca, J., *Analytical Design of an Air Curtain*, Int. J. of Modelling and Simulation, Vol. 15, pp. 14-22, 1995.